

STAFF MEMO

Forecasting demand for various denominations of notes and coins using error correction models

NO. 1 | 2015

BENT VALE

MARKETS AND
BANKING SERVICES



NORGES BANK

Staff Memos present reports and documentation written by staff members and affiliates of Norges Bank, the central bank of Norway. Views and conclusions expressed in Staff Memos should not be taken to represent the views of Norges Bank.

© 2015 Norges Bank

The text may be quoted or referred to, provided that due acknowledgement is given to source.

Staff Memo inneholder utredninger og dokumentasjon skrevet av Norges Banks ansatte og andre forfattere tilknyttet Norges Bank. Synspunkter og konklusjoner i arbeidene er ikke nødvendigvis representative for Norges Bank.

© 2015 Norges Bank

Det kan siteres fra eller henvises til dette arbeid, gitt at forfatter og Norges Bank oppgis som kilde.

ISSN 1504-2596 (online)

ISBN 978-82-7553-858-9 (online)

Forecasting demand for various denominations of notes and coins using error correction models*

Bent Vale[†]

Norges Bank (The central bank of Norway)

March 23, 2015

Abstract

In this paper we present a set of error correction models in order to forecast separately the change in demand for each of the notes and coins issued by Norges Bank. Such forecasts can play a role in planning how many new banknotes and coins Norges Bank should order from its producers. The explanatory variables upon which we condition the forecasts include: households' point of sales consumption, the number of EFTPOS terminals, money market interest rate, as well as some dummies for particular events. The estimated effects seem overall to correspond with findings by other studies. Interestingly, we find that as consumers to a larger extent use EFTPOS cards for their point of sales consumption, holdings of the lowest value denomination coin increase, something we attribute to consumers leaving stocks of low value coins at home since they are less frequently used for paying.

*Thanks to Trond Eklund who initiated this project and together with Karianne Sæther provided the description of the system for production and distribution of cash in Norway. The latter also provided the data. Both colleagues have in addition given valuable feedback. Furthermore, many thanks to Farooq Akram and Øyvind Eitrheim for helpful discussions during the work with this paper. Also thanks to André Anundsen and Claudia Foroni for comments to a recent version of this paper. Nevertheless, views and conclusions presented here are the responsibility of the author and cannot necessarily be attributed to the persons mentioned above.

[†]Address: Norges Bank, Box 1179, Sentrum, N-0107 Oslo, Norway.
E-mail: bent.vale@norges-bank.no

1. Introduction

This paper presents models for forecasting changes in the demand for the various denominations of banknotes and coins in Norway. The model is used in order to determine the necessary production of new coins and notes. The paper is organized as follows: In Section 2 we present a brief overview of the system for production and distribution of cash in Norway, whereas section 3 sets out the system for determining the production of new notes and coins and how the forecasting model fits into that framework. In Section 4 we then present the general model to be used, discuss some econometric issues like identification and potential endogeneity problems, and not the least we discuss how to use the models estimated for forecasts. Data are presented in Section 5. In Section 6 the estimated models and their ability to forecast are presented. Finally, we provide some concluding remarks in Section 7.

2. Norges Banks role and responsibility in cash distribution

Under the Norges Bank Act, Norges Bank (NB) has the exclusive right to issue notes and coins. This implies an obligation to issue in order to meet the needs of the economy and to ensure that an adequate supply of the notes and coins issued is available to the public. Notes and coins in circulation must be of a certain quality in order to function as an efficient means of payment. Norges Bank has an overriding responsibility for maintaining this quality as well as an obligation to accept worn and damaged notes and coins and replace them with notes and coins of acceptable quality.

Norges Bank acts as a wholesaler in the cash distribution. Notes and coins are produced by external suppliers: Oberthur and Giesecke & Devrient produce notes, and Mint of Norway produces coins. All these producers have been chosen in a competitive process after Norges Bank invited tenders internationally. Given full information concerning costs, prices and quality, the market participants are best qualified to find good solutions for cash distribution. Norges Bank wishes to encourage them to constantly seek the best solutions based on cost/benefit analyses, and to ensure that distribution sites and processing solutions change in line with the assessments of market participants. This would

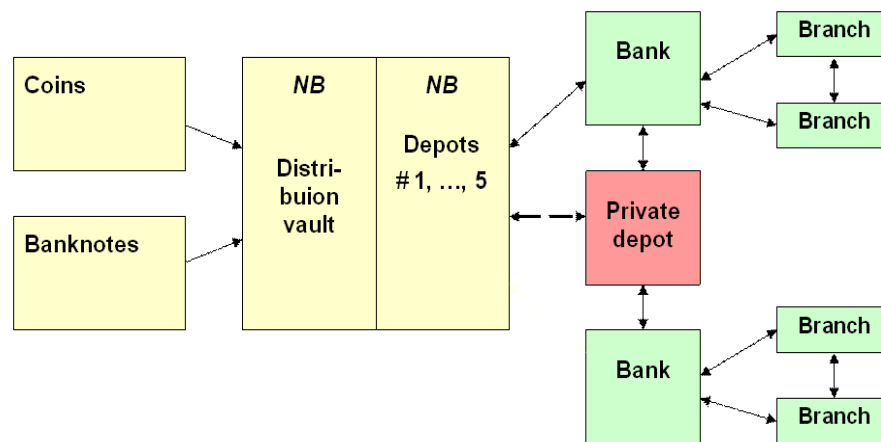

Figure 2.1: The system for distribution of notes and coins in Norway

initially imply that Norges Bank supplies banks from just one business site. Security and logistics considerations may however necessitate having emergency stocks at more than one site. In addition, Norges Bank appears better equipped than banks to transport large amounts over long distances. This implies that Norges Bank should have additional depots and business sites and handle the transport between them in a system that can constitute the “central nerve” of the supply and distribution of cash. Since 2005, Norges Bank has had 5 regional depots in addition to a central distribution vault, as depicted in Figure 2.1. Within the five regions, banks are responsible for supplying cash to their customers and for redistributing cash among different banks and bank branches. Moreover the banks are responsible for quality sorting. Banknotes have to be sorted into fit and unfit according to the central bank guideline prior to deposits in the central bank. To facilitate an efficient redistribution within the region, Norges Bank offers a measure referred to as private depot where Norges Bank on certain conditions pays interest rate compensation on banks’ holdings of coins and notes.

Norges Bank issues five denominations of notes: 1000 kroner, 500 kroner, 200 kroner, 100 kroner and 50 kroner. Four denominations of coins are also issued: 20 kroner, 10 kroner, 5 kroner and finally the smallest denomination, 1 krone. Until 1 May 2012 a 50 øre

coin, worth 0.5 kroner was also legal tender. Although it circulated in the period covered by our data, we do not present any demand model for this denomination. Furthermore, we do not estimate a model for the 20-krone coin as Norges Bank has a huge stock of this coin. The reason being that gambling machines that used 20-krone coins were outlawed in 2006 and 2007, resulting in a huge return of 20-krone coins to Norges Bank.

3. Why estimate the need for cash?

Norges Bank is responsible for the availability of a sufficient quantity of cash in order to meet the demand, and thus will have to estimate the future demand for cash. Forecasts of demand for individual denominations are necessary both for ordering and for keeping optimal stock levels of banknotes and coins. Basically, the need to order new banknotes and coins depends on the need to replace the amount of destroyed denominations of banknotes and coins and the change in external demand. The total need for orders of new banknotes and coins to keep Norges Bank's stock level unchanged, NS , may be expressed as:

$$NS = W - D + S. \quad (3.1)$$

W is total withdrawals of banknotes and coins by banks or private depots from Norges Bank's vaults. D is their total deposits into Norges Bank's vaults. S is deposited unfit notes that will be shredded and therefore need to be replaced.¹ Thus, $W - D$ is the net increase in circulation of notes and coins, which will be addressed per denomination in the forecasting model.

Our existing forecasting model provides information on aggregate developments in cash circulation (see Aastveit (2005)). Such models increase the understanding of factors of importance for the total amount of cash circulation and contribute to the information needed for future procurements. In the case of actual orders, there is, however, need for a model which splits the denominations. In Norway the total amount of cash in circulation has been stable for a period of more than five years while the denomination mix has changed.

To meet its mandate of supplying sufficient coins and banknotes to the general public, the Norges Bank has to develop a well defined currency stock policy and a comprehensive

¹The need for replacement of destroyed denominations depends to a certain degree on the Norges Bank's clean note policy.

database for monitoring and planning purposes. A well-founded stock policy is a key measure, it secures the ability to meet variations in demand and defined extraordinary situations in a cost effective way.

A policy for holding stocks of coins and banknotes within the Norges Bank covers:

- transaction stocks decided by ordering policy;
- buffer stocks, or safety stocks, to buffer against uncertainty regarding demand for cash and uncertainty regarding supplier lead-time; and
- contingency stocks to meet extraordinary circumstances.

Transaction stocks serve to cover the expected requirements during the period between one delivery and the next from the producer. When a new delivery arrives, the transaction stock level should be close to zero. The average level of the transaction stock is decided by the order policy — the size of the order and the ordering frequency — which is set to minimize the sum of order, transport and storage costs, see Figure 3.1.

The graph illustrates the framework that is used to decide on the timing of an order. The decline in stocks is estimated on the basis of the forecasts for future change in demand per denomination, as well as destruction of obsolete banknotes and coins, see equation (3.1). Forecasts should be updated quarterly from an updated dataset. The initial forecast together with the anticipated initial lead time is illustrated with the dotted lines. An updated forecast is illustrated with the solid lines. The updated forecast indicates a need to order earlier. In addition, the graph explains another measure, a renegotiated shorter lead time.

These graphs give the necessary information for ordering (time and volume) from suppliers of notes and coins. By minimizing total costs for ordering and for stockholding, and at the same time applying an acceptable risk for obsolete banknotes, one may determine the optimal order volume and subsequent magnitude of transaction stocks.

Buffer stocks or safety stocks serve as a buffer, primarily against uncertainty regarding demand for cash during the lead time. This is referred to as service level or choice of supply capability, i.e., the probability of being able to meet demand for a denomination

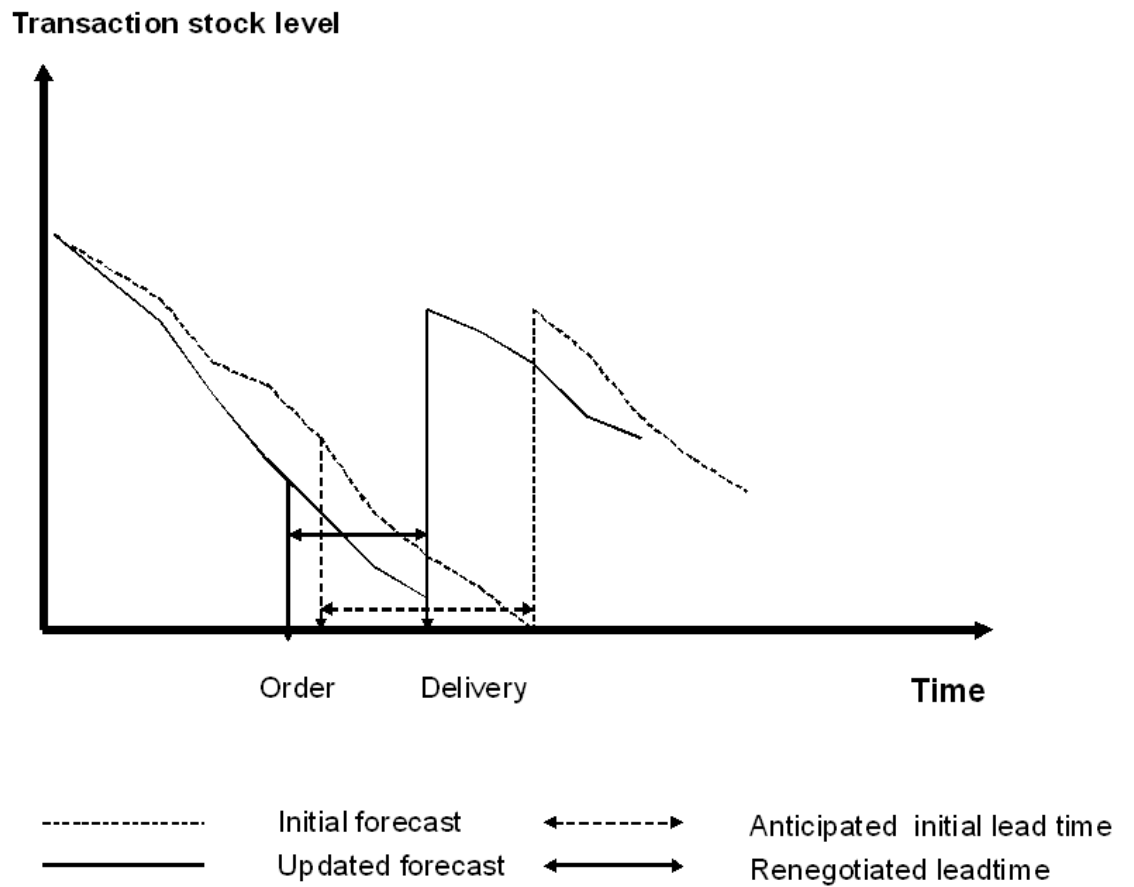

Figure 3.1: Actual and forecasted level of transaction stock

when the transaction stock approaches the level where it needs to be replenished and until a new consignment arrives. Uncertainty may also relate to timing and variation in lead time, both the delivery time agreed with the supplier and the time of transportation. Prior experience indicates that uncertainty related to supplier's delivery time seems to be limited and could therefore be disregarded.

The size of the required buffer stocks depends on the expected variation in demand during the lead time and the required supply capability. To be able to calculate the data for the expected variation per denomination (coins and banknotes) a model for estimating the future demand per denomination is needed. Moreover, the more accurate the model is able to estimate, less stock levels are needed and consequently one will save costs.

In this paper we present the actual models that we have estimated in order to forecast the denomination specific change in demand for cash in the framework described above. The models, which are error correction models, predict the demand for each denomination from all sectors outside Norges Bank conditional upon macroeconomic variables. Among these variables are households' consumption, the number of terminals for electronic funds transefer at point of sale (EFTPOS terminals), and for the high-value denominations the interest rate. These models do not include destruction of notes and coins. The future volumes to be destroyed are estimated from historical data in combination with a possible need to influence on the quality of notes and coins in circulation through adjustments of the fit/unfit border. For banknotes, the major part of the needed order volumes derives from the need to replace shredded notes.

In a few other papers, models estimating the demand for various denominations or groups of denominations have been presented. An early example is Bos (1994) who presents the Dutch central bank's forecasting models of the various denominations of guilder notes. Those models contain to a large degree the same explanatory variables as ours, however they are not error correction models, only simple first difference models of the number of guilder notes in circulation. Since there was little experience with EFTPOS terminals in the early 1990s Bos is unable to estimate econometrically their effects on the circulation of guilder notes. Instead, in the forecasts he relies on assumptions about the effects of EFTPOS terminals based on surveys carried out by the Dutch central bank. There are also some academic papers on the demand for various denominations of cash, papers that are not written with the purpose of forecasting the need for new supply of notes or

coins. Drehman et al. (2002), like our paper, use an error correction model and investigate what distinguishes the demand for high-value notes from the demand for low-value notes. They use a panel of 16 OECD countries (not including Norway) with annual data. They find that economic activity, of course, has a positive impact on the demand, whereas nominal interest rates have a negative effect both on small and large denominations. The number of EFTPOS terminals does not, however, have any significant impact neither on small nor large denominations. Nevertheless, they find that tax to GDP ratio has a slightly positive effect on holdings of high-value denominations but a negative effect on low-value denominations. They interpret this as an indication that high-value notes are partly used as a storing device for tax evasion. Fischer et al. (2004) estimate the demand for the euro legacy currencies in total as well as for low-value and high-value denominations. For the low-value denominations they find that demand is mainly driven by domestic transactions as well as a negative effect from a time trend. This latter effect may capture the gradual substitution away from cash towards electronic payments. For the high-value denominations the demand depends on interest rates. Amromin and Chakravorti (2009) also study the difference between low-value and high value denominations. Their data set is an unbalanced panel with annual data for 13 OECD countries (Norway is not included) for the period 1988 to 2003. They distinguish between large, medium and small denominations. They find that the interest rate only affects the demand for large denominations. The number of ATMs has a negative effect on the medium denominations, and number of EFTPOS terminals has a negative effect on the demand for the low denominations. Finally, in Fischer (2012) a framework for forecasting euro banknotes is presented.

4. Modelling and forecasting strategy

For each of the five banknote denominations and three of the four coin denominations we estimate separate dynamic forecasting models. As the left hand side variable we have the four quarter change in number of notes/coins outstanding. We use an error correction type of model of the general form

$$\Delta_4 y_t = \beta_1 g(L) \Delta_4 y_t + \gamma [y_{t-4} - \beta_2 \mathbf{z}_{t-4}] + \beta_3 g(L) \Delta_4 \mathbf{z}_t + \beta_4 g(L) \mathbf{d}_t + \epsilon_t \quad , \quad (4.1)$$

where $\Delta_4 x_t = x_t - x_{t-4}$, the unit of time is one quarter, $g(L)$ is a polynomial in a lag operator starting at 0 lag, y_t is the stock of notes or coins of a specific denomination in

circulation at the end of quarter t , \mathbf{z}_t is a vector of exogenous explanatory variables, \mathbf{d}_t is a vector of dummies, and ϵ_t is the stochastic residual. The term in square brackets is the error correction term, thus $y_t = \beta_2 \mathbf{z}_t + \nu_t$ is the stationary or cointegrating long run relationship between the exogenous explanatory variables and the stock of note/coin y_t in circulation with a stochastic error term ν_t . The parameter γ represents the relative speed at which a deviation from the long run equilibrium 4 quarters ago is corrected during the ensuing 4 quarters.

Although our data set is quarterly, we consider four quarter changes of y_t and \mathbf{z}_t rather than quarterly changes. This is done in order to filter out seasonal effects.²

To ensure that we have a cointegrating longrun relationship we use an Augmented Dickey-Fuller test to check the stationarity of $\nu_t = y_t - \beta_2 \mathbf{z}_t$. Only if ν_t is stationary do we have a cointegrating long run relationship and (4.1) can be interpreted as an error correction model. The estimation of (4.1) is in most cases done in one step, i.e., the long run relationship is estimated simultaneously with the short run dynamics for the models for notes. When estimating the models for coins, however, we first estimate a valid long term model and use the error correction term ν_t as a right hand side (RHS) variable when estimating the short run or dynamic model (4.1).

For a model to be accepted we also require the long run relationship to have a good economic interpretation. However, for the short run dynamics, we do not aspire to have a full economic interpretation. As common in much of the literature on error correction models, we consider the short run dynamic just to represent various inertias in adaption towards the stationary equilibrium. Economic explanations of these inertias, however, are not the goal of this paper.

We use a general to specific approach in order to determine what variables should be included in \mathbf{z}_t , $\Delta_4 \mathbf{z}_t$ and \mathbf{d}_t at what lags, as well as what lags of $\Delta_4 y_t$ should be included. With this approach we start with a general unrestricted model (GUM) containing all potential exogenous variables with the maximum number of lags (4 quarters). Once the GUM is estimated we test restrictions on the model as exclusions of variables and lags. The validity of these exclusions are tested against the GUM using cumulative F-tests.

²This approach does not, as will be seen when empirical results are presented, rule out the use of seasonal dummies in several of the models. That may be due to the presence of variables in levels (i.e., not as differences) in the models.

After all the valid exclusions we end up with the preferred parsimonuous model.³

The potential exogenous variables are

PC_t Point of sale consumption (POS consumption) by the household sector, nominal un-adjusted values. POS consumption is defined as those consumer goods and services for which consumers are likely to consider using notes and coins.⁴

$etrm_t$ Number of terminals for electronic funds transfer at point of sales (EFTPOS) at the end of current year of quarter t , i.e., annual frequency.

$atm100_t$ Trend variable for phasing out of the 100-kroner note as an ATM denomination. Details are presented in Section 6.1.2.

$DM10_t$ A dummy representing a particular shift in the demand for the 10-krone coin as result of regulation of small scale gambling, 1 from 2002q1 on until and including 2004q1, 0 otherwise. See Section 5 for further explanations.

rk_t Dummy for periods when private banks or their cash depots have received interest compensation for holding notes and coins, 1 as of 2005q4 and forwards, 0 otherwise.

r_{NB} Norges Bank's key policy interest rate (effective interest rate).

qh_t Seasonal dummy for quarter h .

Norges Bank's strategy in supplying notes and coins is purely adaptive. I.e., Norges Bank supplies the number of notes and coins of the various denominations that the private banks demand at any time. This has implications for our identification strategy. None of the right hand side or the explanatory variables in (4.1) will influence the supply of banknotes and coins directly, they will only do so through the demand. Hence, we can be confident that in estimating models like (4.1), we actually identify demand equations.

In almost all models of demand for money, a variable representing transactions for which the money is used as a means of payment is included. In our models where money is confined to various denominations of notes and coins the relevant transactions are those

³This model reduction is performed using Automatic model selection in OxMetrics.

⁴Consumption categories from the quarterly national accounts include 62A, 62B, 62C, 62E6, 62F1, 62G2, 62G3 62G4, 62G5, 62I3, 62I4 and 62K

where the consumers can use notes and coins as a fairly convenient payment instrument. Those will be transactions where payments are done at the point of sales. That is why we have limited the transactions variable to the household sector's consumption of such consumption goods, henceforth referred to as POS consumption. Furthermore, for other domestic demand components of the GDP like consumption by other institutional sectors of the economy or for investment, notes and coins are an unlikely instrument of payment.

For POS consumption the most widely used alternative to cash in Norway are debit cards used as a payment instrument for EFTPOS transactions. Whether consumers prefer to use cash or EFTPOS debit cards will depend on price and convenience.⁵ The price consists of a fixed fee for having an EFTPOS card and a fee charged every time the consumer uses the card. An average across banks of the fees listed by banks are available at an annual basis. However, these listed fees are to a large extent not equivalent to the actual fees faced by consumers. That is due to various types of discounts for preferred bank customers, i.e., customers with a minimum number of services bought from the bank. The extent of such discounts has increased throughout our sample period. Unfortunately, we do not have any exact annual number of the share of bank customers getting such discounts or the size of the discounts. Hence, we are left with a measure of the convenience for consumers of using debit cards, the number of EFTPOS terminals, observed annually.⁶

One would also expect that the availability of ATMS would influence the demand for the notes that are ATM denominations. However, there is not much variation in the number of ATMs during our sample period (from 1944 to 2283), and the variable is also highly correlated with the number of EFTPOS terminals (0.875). What seems to matter more than the number of ATMs is whether a certain denomination is an ATM denomination or not. This is evidenced in the development of the 100-krone note which during our sample period is gradually phased out as ATM denomination (see Figure 5.1 and the ensuing discussion in Section 5). Based on these moments we do not include the number of ATMs in any of the models.⁷

⁵See Humphrey et al. (1996), Humphrey et al. (2001) as well as Bolt et al. (2008)

⁶Credit cards have not been widely used by Norwegian consumers in their POS purchases. However, towards the end of our sample period, credit cards that can be used at EFTPOS terminals have to some extent been used by consumers. The convenience of using such credit cards will also be captured by the explanatory variable $etrm_t$.

⁷Previous attempts at doing so indicated strong problems of multicollinearity, both $etrm_t$ and the number of ATMs would typically become insignificant and/or get signs without any economic interpretation.

At least for higher value denominations, which to some extent may serve as a means to store value, one might expect the demand to depend on the level of interest rate, like in many models of money demand, in particular for non-interest-bearing money.

In general, including variables like $etrm_t$ or the number of ATMs as explanatory variables may in general cause an endogeneity problem. For instance, in the case of EFTPOS terminals merchants may actually install terminals in order to stem the use of cash by consumers, thus $etrm_t$ may depend on y_t and be endogenous to our problem. However, in all models where $etrm_t$ is included, it is included with lags. In that way we break the causality that may create an endogeneity problem.

4.1. Models' ability to forecast

From all eight models we produce post-sample forecasts over 8 quarters. This is the typical interval between new orders of a denomination. In all models we have lagged endogenous variables y_{t-h} and/or Δy_{t-h} as RHS variables. Denote the last quarter of the estimation sample by T . When forecasting $\Delta_4 y_{T+1} \dots \Delta_4 y_{T+8}$, for the lagged endogenous variables we only use actual data on y_t until y_T . From $T+1$ and onwards we use the forecasted values of y_t for the lagged endogenous variables. This method of forecasting is often referred to as dynamic or recursive forecasting in the literature.

We could instead have done one-step-ahead static forecasts, which involves using the actual values of y_t beyond T for as long as we have data on y_t . However, by preferring the dynamic forecasting method we put ourselves in the position of the cashier's department when they are forecasting the demand for a denomination of kroner: When at time T they want to forecast changes in demand 8 quarters ahead the most recent observation of y_t available to them will be y_T . For $T+1$ and onwards they have to rely on forecasts of y_t .

In order to evaluate the ability of these models to forecast for the post-sample period we use the currently most up to date data on the exogenous variables z_t . I.e., regarding the exogenous variables we do not put ourselves in the position of the cashier's department. The reason for this choice is simple: we just want to evaluate the forecast ability of our estimated models, not the ability of other forecasters to predict variables exogenous in our models.

5. Data and special events relating to demand for cash

The data consist of quarterly observations on the numbers of outstanding notes and coins of each denomination issued by Norges Bank from 1998q1 until 2010q3, i.e., for 51 periods. However we only use data from 1998q1 until 2008q3 for estimation, leaving the eight quarters 2008q4 – 2010q3 for post-sample predictions. Adjusting for the various lags used in the eight models the number of observations in estimation ranges from 35 to 39.

Notes and coins outstanding include all notes and coins held by households, financial⁸ and non-financial firms, local and central government institutions other than Norges Bank, as well as residents, private and government institutions in other countries.

Data for the quarterly POS consumption is collected from the quarterly national accounts.⁹

The annual numbers of EFTPOS terminals are from Norges Bank's Annual Report on Payment Systems. The number of terminals increases from 52,235 in 1998 to 131,079 in 2009.¹⁰

The stock numbers of outstanding notes and coins are shown in Figures 5.1 and 5.2.

As is apparent from Figure 5.1, for the 200-krone notes and the 500-krone notes there was a steady increase during our period of almost 11 years. During this period, the former has continuously been a standard ATM denomination whereas the latter has become a widely used ATM denomination. There was also a fairly steady but weaker growth in the use of 50-krone notes (a non-ATM denomination), whereas the 100-krone note had a steady and fairly strong decline during the first half of the period. This is the time when it largely was phased out as an ATM denomination. The 1000-krone note is only rarely used as an ATM denomination. Over the whole period the number of 1000-krone notes outstanding fell, but there was a slight increasing trend between 2003 and 2007. This

⁸That includes the bank owned cash handling firm NOKAS

⁹For POS consumption actual data from the quarterly national accounts are used until 2010q2. For 2010q3 we assume the same 12 months growth as in overall household consumption from 2009q3 till 2010q3.

¹⁰See <http://www.norges-bank.no/en/about/published/publications/annual-report-on-payment-systems/> . Numbers are recorded from the report for 2009 and previous. For 2010 we assume the same growth rate in EFTPOS terminals as from 2008 to 2009.

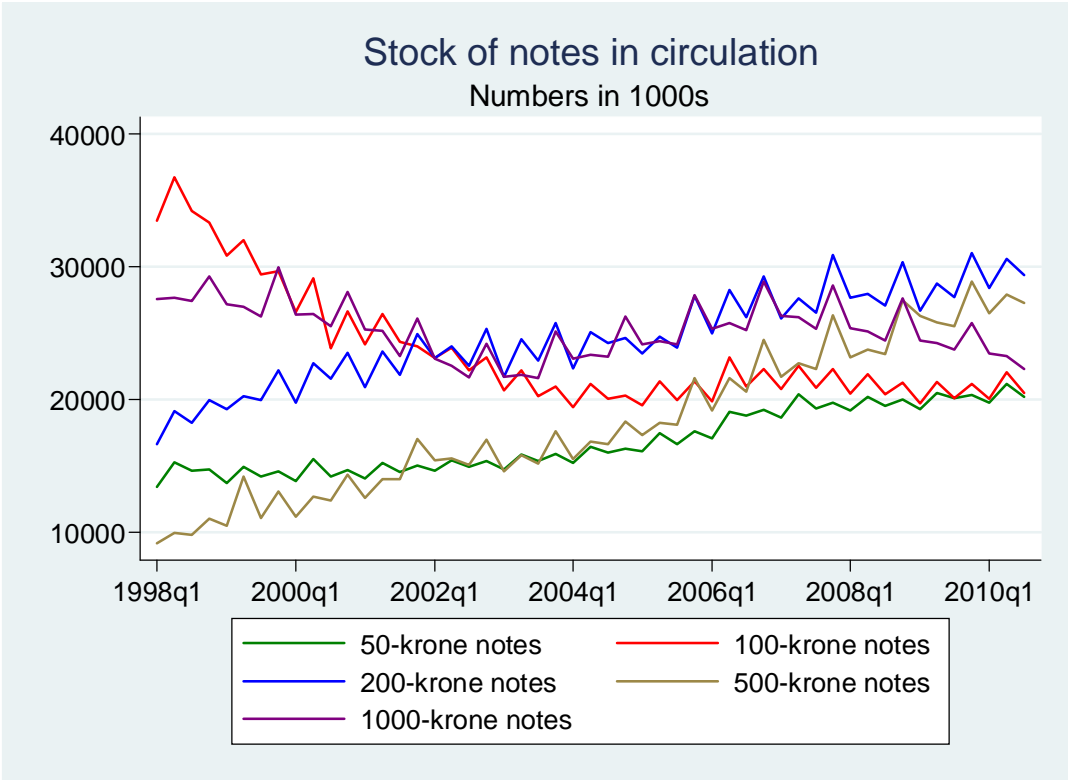

Figure 5.1: Number of notes outstanding in 1000s from 1998q1 till 2010q3

note is probably mostly used as a store of value and in some large POS transactions like second hand car purchases. It may also be used in illegal transactions more so than other notes, simply because it is the largest value denomination. For all denominations there is evidence of cyclical patterns.

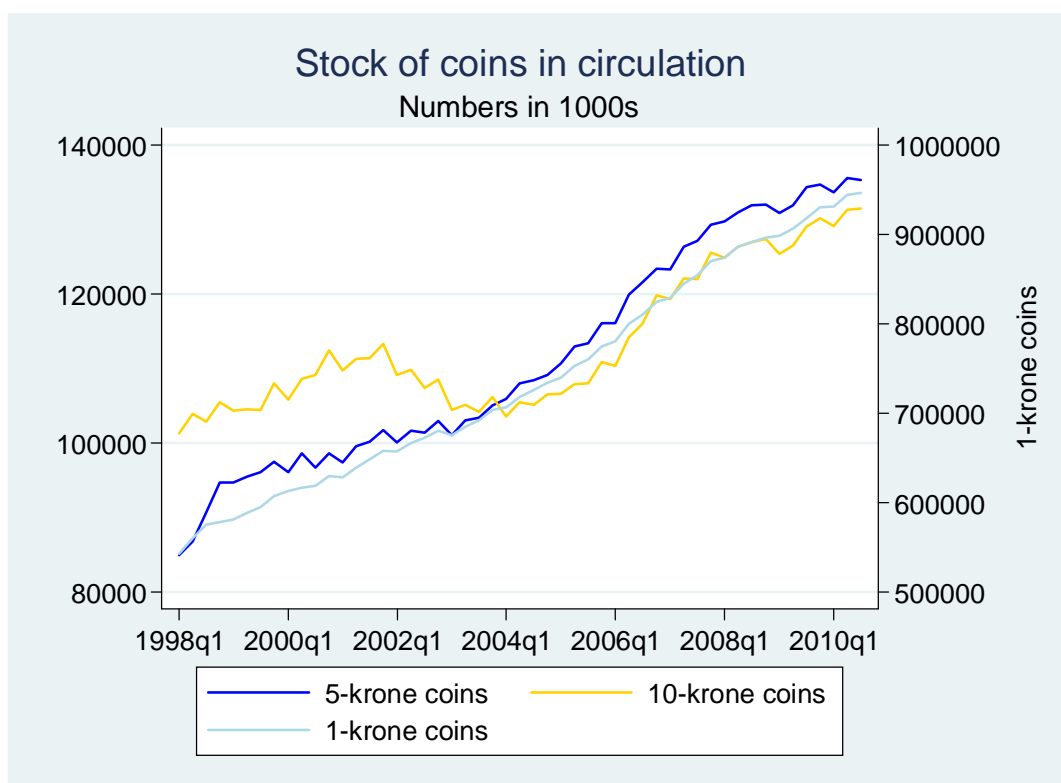

Figure 5.2: Number of coins outstanding in 1000s from 1998q1 till 2010q3.

Figure 5.2 shows that there was a steady rise in the stock of both the 1-kroner coin and the 5-kroner coin. A notable feature is that the 1-kroner note is by far the most widely used coin in terms of the number of coins in circulation. By the end of the sample there were almost 1 billion 1-kroner coins in circulation, whereas the number of 5-kroner coins in circulation was "only" a little less than 140 millions. Unlike for the notes, there is little evidence of any cyclical patterns in the number of 1-kroner coins in circulation. There is a fall in the number of 10-kroner coins in circulation between 2002q1 and 2004q1. This is related to introduction of restrictions on slot machines for gambling in this period.

6. Results of model estimation and forecasting

First we report the estimated models and forecasts for the 5 notes in increasing order of denomination value. Then follows the 3 coin debominations in the same order. We report the values of the estimated parameters with corresponding t -values, as well as misspecification tests and tests of stationarity for the residuals of the long run model. Economic interpretations of the models and their ability to forecast the change in demand for the respective notes and coins 8 quarters ahead out of sample, are discussed. Estimation sample for all models is 1998q1 to 2008q3, with adjustments of the starting period as required by the number of lags. The out-of-sample forecasting period thus stretches from 2008q4 to 2010q3. Ending the estimation sample as early as 2008q3 enables us to compare the models' forecast to the actual development in the circulation of each denomination over a horizon corresponding to the lead time between orders and deliveries of notes, cf. Figure 3.1.

6.1. Forecasting models for the notes

All five models for the notes are estimated in one step.

6.1.1. 50-krone note

For the 50-krone note we have the following preferred model

$$\begin{aligned} \Delta_4 M50_t = & \underset{(6.13)}{4925.5} + \underset{(4.29)}{0.353} \Delta_4 M50_{t-2} - \underset{(-8.17)}{0.894} \cdot M50_{t-4} + \underset{(7.19)}{0.102} \cdot PC_{t-4} \quad (6.1) \\ & + \underset{(4.53)}{774.5} \cdot rk_{t-1} + \underset{(3.62)}{0.148} \cdot \Delta_4 PC_t - \underset{(-6.05)}{875.1} \cdot q3_t - \underset{(-5.28)}{898.3} \cdot q4_t \end{aligned}$$

| | | |
|----------------|-------------|------|
| R^2 | 0.8397 | |
| AR 1-2 test | $F(2, 27)$ | 0.53 |
| ARCH 1-1-test | $F(1, 27)$ | 0.59 |
| Normality test | $\chi^2(2)$ | 0.33 |
| Hetero test | $F(11, 17)$ | 0.37 |
| RESET test | $F(1, 28)$ | 0.16 |
| Number of obs. | 37 | |

For the misspecification tests, p -values are reported.

The estimated forecasting model passes the misspecification tests. From (6.1) we can derive the following long run equilibrium model

$$M50_{t-4} = 5508.9 + 0.114PC_{t-4} + 774.5rk_{t-1} + \nu_t \quad (6.2)$$

The Dickey-Fuller test for stationarity of ν_t confirms that this is a cointegrating relationship. The test statistic is -5.307 whereas the 1% critical value for this test is -3.668 .

As one might expect, the demand for 50-krone notes depends positively on the POS consumption. As intended, the demand also reacts positively to introduction of the interest compensation for holding notes and coins. Being a small denomination note, the demand for it does, however, not react to the level of interest rate. Neither does it depend on the availability of EFTPOS terminals. This is in accordance with findings by ten Raa and Shestalova (2002) and Bergman et al. (2007) who calculate the maximum size of a consumer transaction where cash is preferable to cards, to be somewhat above the value of the 50-krone note.

To check the ability of (6.1) to forecast we present a plot of the actual values of $\Delta_4 M50_t$ (in red) and the predicted values (in blue). The residuals or forecast errors are marked as green vertical spikes. Observations to the left of and including at the grey dotted vertical line represent in-sample forecasting, whereas the out of sample forecasting is to the right of the vertical line.

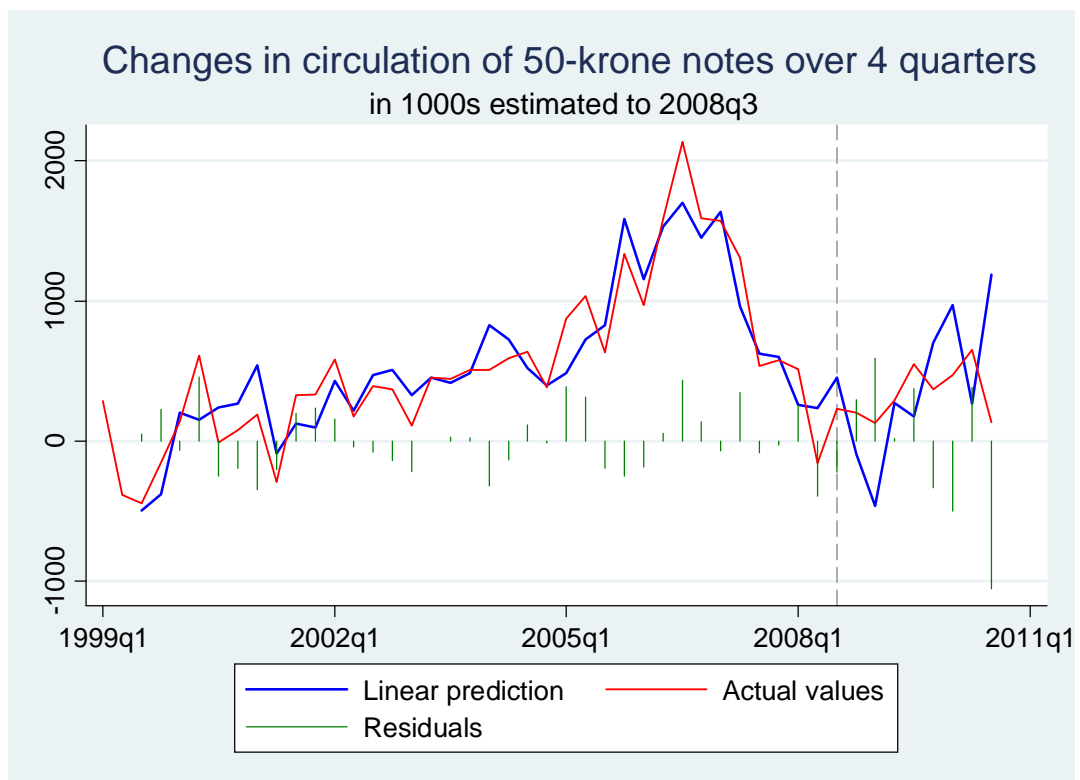

Actual values in red and the predicted values in blue. The residuals or forecast errors are marked as green vertical spikes. Observations to the left of and including at the grey dotted vertical line represent in-sample forecasting, whereas the out of sample forecasting is to the right of the vertical line.

The model predicts fairly well in-sample, whereas the out-of-sample forecasts have somewhat larger residuals. But, the model seems to be able to capture a slightly increasing trend in $\Delta_4 M_{50_t}$ after 2009q1. The forecast does anyhow seem to be somewhat more volatile than the actual development of $\Delta_4 M_{50_t}$. In order to smooth the forecast of the change in circulation of the 50-krone notes we calculate the average of $\Delta_4 M_{50_t}$ for all the 8 post-sample quarters. In that way we avoid the risk of putting too much weight on one of the outlying forecasts. Using this smoothing method we arrive at a forecast of growth in the circulation of 50-krone notes from 2008q3 to 2010q3 of 757,333 notes compared to the actual growth of 687,471 notes. If instead we had added the two four-quarters forecasts at 2009q3 and 2010q3 we would have got a forecast of 1367,115, the double of the actual value. In this case the smoothing method performs far better than simple adding up of two ensuing four-quarters forecasts.

6.1.2. 100-krone note

When estimating a forecast for the 100-krone notes we need to take into account the gradual phasing out of the 100-krone note as an ATM denomination during the first part of our estimating sample. Unfortunately we lack data on how many ATMs that offer the various denominations. Instead we approach this phasing out by adding a simple linear trend variable as follows

$$atm100_t = \begin{cases} 176 - t & \text{if } t \leq 2003q4 \\ 0 & \text{if } t > 2003q4 \end{cases} .$$

The numerical value of 2004q1 is 176.¹¹ Thus, $atm100_t$ takes the value of 18 in the first quarter of the sample over which (6.3) below is estimated (1999q3), it becomes 1 in 2003q4 and 0 thereafter.

The preferred model for forecasting $\Delta_4 M100_t$, the four quarter change in the circulation of 100-krone notes is

$$\begin{aligned} \Delta_4 M100_t = & \underset{(3.16)}{8211.0} + \underset{(2.57)}{0.300} \Delta_4 M100_{t-2} \underset{(-4.14)}{-0.773} \cdot M100_{t-4} & (6.3) \\ & + \underset{(4.25)}{0.077} \cdot PC_{t-4} + \underset{(3.42)}{395.3} \cdot atm100_{t-4} + \underset{(5.29)}{0.194} \cdot \Delta_4 PC_t \\ & - \underset{(-10.59)}{0.107} \cdot \Delta_4 etrm_{t-1} \underset{(-2.88)}{-0.071} \cdot \Delta_4 etrm_{t-4} + \underset{(1.95)}{727.9} \cdot q2_t - \underset{(-2.72)}{771.6} \cdot q3_t \end{aligned}$$

| | | |
|----------------|-------------|------|
| R^2 | 0.9079 | |
| AR 1–2 test | $F(2, 25)$ | 0.76 |
| ARCH 1–1-test | $F(1, 25)$ | 0.92 |
| Normality test | $\chi^2(2)$ | 0.00 |
| Hetero test | $F(16, 10)$ | 0.81 |
| RESET test | $F(1, 26)$ | 0.20 |
| Number of obs. | 37 | |

For the misspecification tests, p -values are reported.

The estimated model passes misspecification tests except the one for normality of the residuals, this calls for some caution in the interpretation of t -values assigned to the coefficient estimates. From (6.3) we can derive the following long run equilibrium model

$$M100_t = 10622.3 + 0.1055PC_t + 511.4atm100_t + \nu_t \quad . \quad (6.4)$$

From the Dickey-Fuller test of ν_t we get clear support of (6.4) being a cointegrating relationship. The test statistic is -6.594 versus a 1% critical value of -3.668 .

¹¹The numerical representation of t is set equal to the number of quarters since 1960q1 in the statistics package we are using for organizing the data, STATA.

The transaction variable PC_t also shows up in this model, as do the trend variable for phasing out the 100-krone note as an ATM denomination. Note that the trend variable has a higher value the more ATMs that offer 100-krone notes, hence its positive sign. As in the long run equilibrium model for the 50-krone note (6.2), the number of EFTPOS terminals does not enter (6.4). Nevertheless, it is part of the short run dynamics in (6.3).

To assess the ability of (6.3) to forecast, below we present a plot of actual values and predicted values of $\Delta_4 M100_t$.

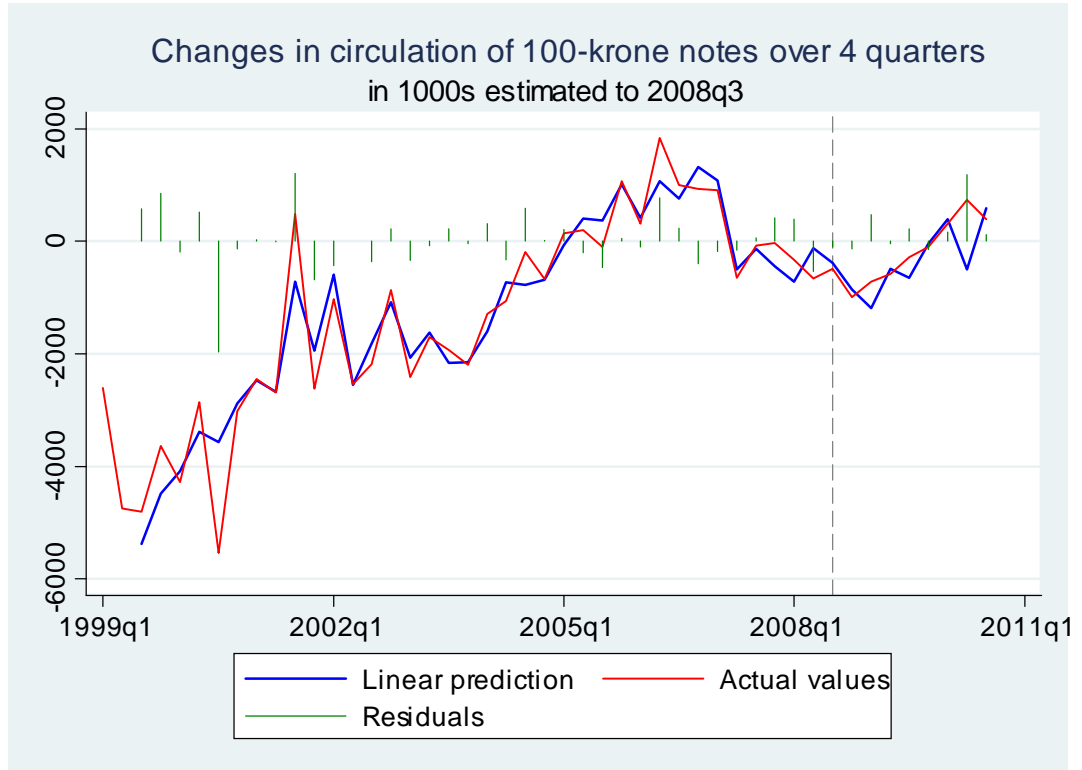

Actual values in red and the predicted values in blue. The residuals or forecast errors are marked as green vertical spikes. Observations to the left of and including at the grey dotted vertical line represent in-sample forecasting, whereas the out of sample forecasting is to the right of the vertical line.

The model predicts rather well in-sample. Out-of-sample it is able to capture the rising trend in the actual values, but it shows higher volatility than can be found in the actual values. Using the same smoothing technique as described in Section 6.1.1 for the 50-krone note in order to forecast the change in circulation of 100-krone notes during the eight quarters following 2008q3, we get a forecast of $-683,453$ notes as opposed to an actual increase of $110,643$ notes. By instead adding the two ensuing four quarter forecasts at 2009q3 and 2010q3, we get a forecast of $-66,156$, closer to the actual value. I.e., in this case simply adding the two four quarter forecasts would produce a better

forecast. Nevertheless, it is evident from the plot that the model has a slight tendency of underpredicting in the post-sample period.

6.1.3. 200-krone note

For the 200-krone notes we have the following preferred model

$$\begin{aligned} \Delta_4 M200_t = & +10961.7 - 0.796 \cdot M200_{t-4} + 0.038 \cdot PC_{t-4} & (6.5) \\ & \quad (4.96) \quad -4.36 & \quad (1.18) \\ & + 0.049 \cdot etrm_{t-4} + 1443.1 \cdot rk_{t-4} + 1236.7 \cdot \Delta_4 rk_t \\ & \quad (3.67) & \quad (3.28) & \quad (2.83) \\ & + 0.180 \cdot \Delta_4 etrm_{t-3} - 0.176 \cdot \Delta_4 etrm_{t-4} + 1189.7 \cdot q2_t + 2006.0 \cdot q4_t \\ & \quad (7.31) & \quad (7.95) & \quad (2.40) & \quad (3.88) \end{aligned}$$

| | | |
|----------------|-------------|------|
| R^2 | 0.6749 | |
| AR 1–2 test | $F(2, 27)$ | 0.33 |
| ARCH 1–1-test | $F(1, 27)$ | 0.43 |
| Normality test | $\chi^2(2)$ | 0.47 |
| Hetero test | $F(14, 14)$ | 0.93 |
| RESET test | $F(1, 28)$ | 0.31 |
| Number of obs. | 39 | |

For the misspecification tests, p -values are reported.

The estimated model passes all the misspecification tests. From (6.5) we can derive the following long run equilibrium model

$$M200_t = 13771.0 + 0.048PC_t + 0.062etrm_t + 1813.4rk_t + \nu_t \quad . \quad (6.6)$$

The Dickey-Fuller test for ν_t clearly indicates that (6.6) is a cointegrating relationship. The test statistic is -10.063 versus a 1% critical value of -3.655 .

Like with the 50-krone note, but unlike the 100-krone note, there is a very strong effect from the introduction of interest compensation. POS consumption in levels is forced to be part of the dynamic model although it has a t -value of only 1.18. In the long run though it has a t -value of 1.36 and corresponding p -value of approximately 20%. The number of EFTPOS-terminals has a positive influence on the demand for 200-krone notes. That may seem at odds with cash and debit cards being substitutes when consumers buy POS goods or services. However, we need to take into account the availability of cash-back at most EFTPOS terminals. Consumers paying with debit cards have strong incentives to withdraw cash from the check-out registries in stores rather than using ATMs. There is no fee on getting cash-back when paying with an EFTPOS card as opposed to getting cash

from an ATM. In addition, the density of ATMS has decreased in the large cities. When withdrawing cash the 200 kroner note is a popular currency, as it is convenient to use for many cash transactions. This effect seems to outweigh the effect of substitution between cash and debit cards.

Below, we plot the actual values and the forecasted values of the four quarterly changes in the circulation of the 200-krone note.

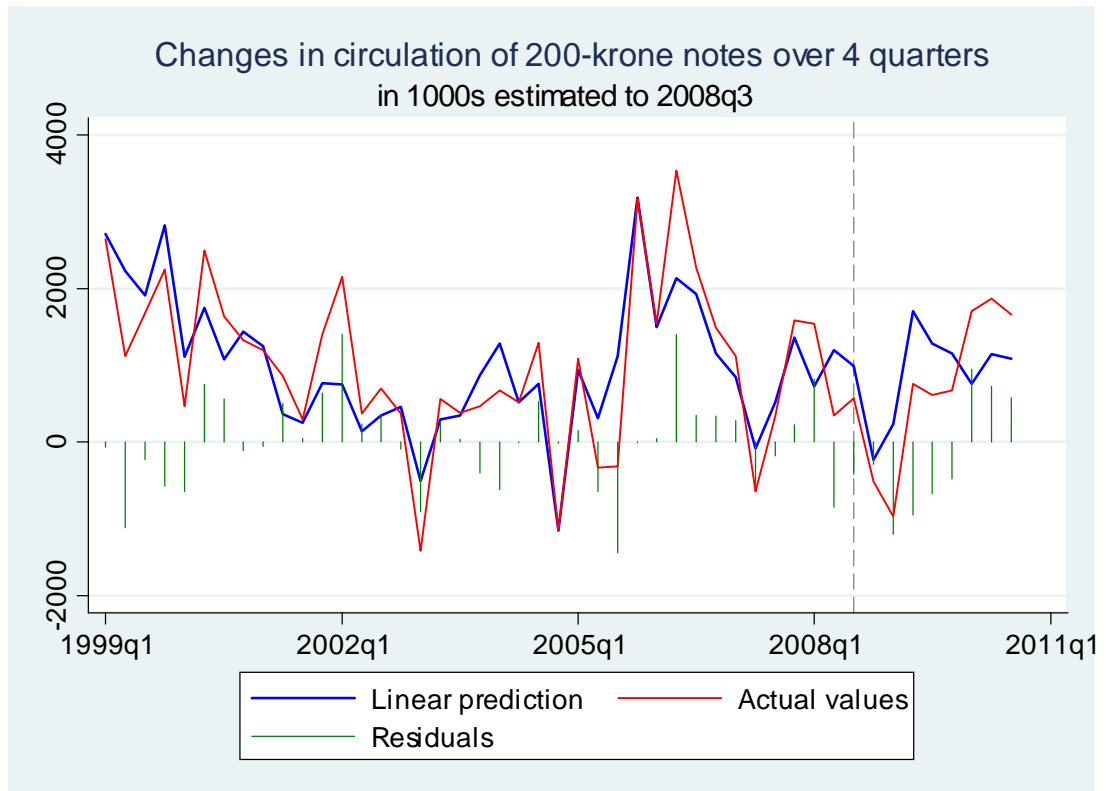

Actual values in red and the predicted values in blue. The residuals or forecast errors are marked as green vertical spikes. Observations to the left of and including at the grey dotted vertical line represent in-sample forecasting, whereas the out of sample forecasting is to the right of the vertical line.

The model predicts fairly well in-sample. Out-of-sample, it overpredicts for the first five quarters then underpredicts for the next three. Using the smoothing technique (see Section 6.1.1) we get a forecast of the eight quarter change in the circulation of 200-krone notes after 2008q3 of 1,785,372 compared to an actual change of 2,280,188. By instead adding the two four-quarters forecasts at 2009q3 and 2010q3, we get a forecast of 2,369,776, even closer to the actual value. I.e., in this case, as with the 100-krone note simply adding the two four quarter forecasts gives a better prediction.

6.1.4. 500-krone note

For the 500-krone notes we have the following preferred model

$$\begin{aligned} \Delta_4 M500_t = & -0.454 \cdot M500_{t-4} + 0.135 \cdot PC_{t-4} - 420.2 \cdot r_{NB,t-4} & (6.7) \\ & (-6.68) & (8.26) & (-6.15) \\ & -0.284 \cdot \Delta_4 PC_t + 965.0 \cdot \Delta_4 rk_{t-3} + 325.3 \cdot \Delta_4 r_{NB,t-4} \\ & (-3.70) & (3.27) & (7.65) \\ & -922.4 \cdot q3_t \\ & (-3.48) \end{aligned}$$

| | | |
|----------------|-------------|------|
| R^2 | 0.9057 | |
| AR 1–2 test | $F(2, 30)$ | 0.31 |
| ARCH 1–1-test | $F(1, 30)$ | 0.38 |
| Normality test | $\chi^2(2)$ | 0.36 |
| Hetero test | $F(12, 19)$ | 0.80 |
| RESET test | $F(1, 31)$ | 0.65 |
| Number of obs. | 39 | |

For the misspecification tests, p -values are reported.

The model passes all the misspecification tests. From (6.7) we derive the following long run equilibrium model

$$M500_t = 0.297PC_t - 926r_{NB} + \nu_t \quad . \quad (6.8)$$

The Dickey-Fuller test for ν_t may indicate that (6.8) is a cointegrating relation, however, the p -value of the test statistic is as high as 5.7%.

In addition to the transaction variable POS consumption, the interest rate level enters with a negative sign. For the 2nd largest denomination this is what one could expect. The fact that the number of EFTPOS terminals does not enter, neither in the long run nor in the short run dynamics, may be because of the two opposing effects, the substitution over to electronic payments as EFTPOS terminals become more available and the demand for 500-krone notes in cash-back at EFTPOS terminals.

Below, we plot the actual values and the forecasted values of the four quarterly changes in the circulation of the 500-krone note.

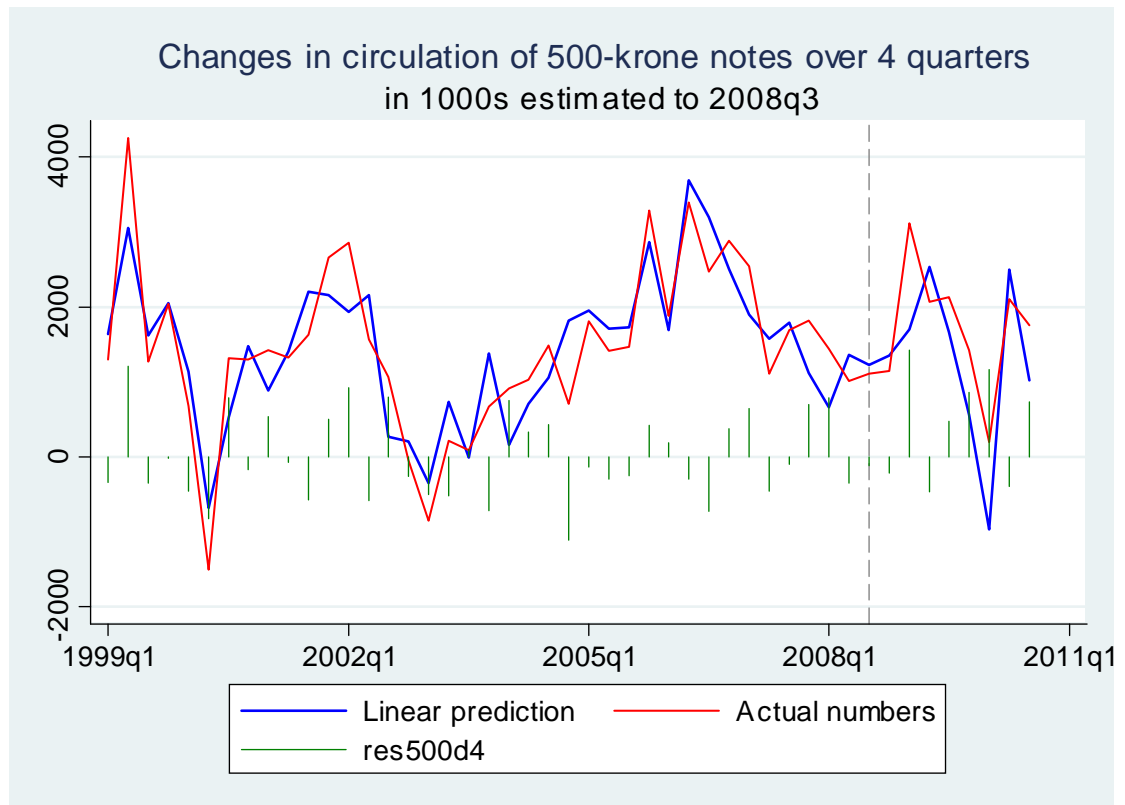

Actual values in red and the predicted values in blue. The residuals or forecast errors are marked as green vertical spikes. Observations to the left of and including at the grey dotted vertical line represent in-sample forecasting, whereas the out of sample forecasting is to the right of the vertical line.

The model predicts fairly well in-sample. Out-of-sample (after 2008q3) it seems to underpredict somewhat. The actual change in the circulation of 500-krone notes from 2008q3 and 8 quarters ahead was 3,887,632 notes. The smoothing method gives a forecast of 2,592,864. The sum of the two predicted 3rd quarter values after 2008q3 gives a forecast of 2,685,168, i.e., a tiny bit closer to the actual value than the smoothing method.

6.1.5. 1000-krone note

For the 1000-krone notes we have estimated the following preferred model

$$\begin{aligned} \Delta_4 M1000_t = & \underset{(4.18)}{0.291} \cdot \Delta_4 1000_{t-2} + \underset{(8.01)}{0.507} \cdot \Delta_4 1000_{t-3} & (6.9) \\ & + \underset{(5.79)}{9504.6} - \underset{(-6.41)}{0.337} \cdot M1000_{t-4} - \underset{(-6.41)}{0.019} \cdot etrm_{t-4} \\ & + \underset{(5.76)}{0.159} \cdot \Delta_4 PC_t + \underset{(1.86)}{0.090} \cdot \Delta_4 PC_{t-1} - \underset{(-4.06)}{221.1} \cdot \Delta_4 r_{NB,t} + \underset{(4.00)}{491.0} \cdot \Delta_4 rk_{t-1} \\ & - \underset{(-4.63)}{776.9} \cdot q1_t - \underset{(-5.60)}{877.2} \cdot q2_t - \underset{(-4.56)}{1132.1} \cdot q3_t \end{aligned}$$

| | | |
|----------------|-------------|------|
| R^2 | 0.9690 | |
| AR 1-2 test | $F(2, 22)$ | 0.40 |
| ARCH 1-1-test | $F(1, 22)$ | 0.67 |
| Normality test | $\chi^2(2)$ | 0.39 |
| Hetero test | $F(12, 19)$ | 0.77 |
| RESET test | $F(1, 31)$ | 0.74 |
| Number of obs. | 36 | |

For the misspecification tests, p -values are reported.

The model passes all the misspecification tests. From (6.9) we derive the following long run equilibrium model

$$M1000_t = 28203.6 - 0.056etrm_t + v_t \quad . \quad (6.10)$$

The Dickey-Fuller test of v_t indicates that (6.10) is a cointegrating relation. The p -value of the test statistic is 2.34%.

The transaction variable POS consumption does not enter the long run equilibrium model, it only appears in the short run dynamics. This may reflect that the 1000-krone note is less used as a means of payment in POS transactions. Similarly, the rise in the number of EFTPOS terminals seems to reduce the demand for 1000-krone note as a transaction note in the longer run. This result is in some contrast to the finding by Amromin and Chakravorti (2009) that only demand for small denominations had such a negative influence from the introduction of more EFTPOS-terminals. Our results may indicate that 1000-krone notes have been used in ordinary POS transactions. The reason may be that compared to some of the countries covered by Amromin and Chakravorti, Norway has a smaller value of its largest denomination relative to the price level.

The larger part of the long run equilibrium value of $M1000_t$ seems not to be explained by the exogenous variables used in this model. Note that the constant term is fairly close to

the average number of 1000-krone notes in circulation in the sample period. The interest rate appears at least in the short run dynamics of the model, pointing to the store of value aspect of the high-value denominations. As with the other denominations, except the 100-krone note, there is a clear effect from the introduction of interest rate compensation to the banks and their common cash holding corporation.

Below, we plot the actual values and the forecasted values of the four quarterly changes in the circulation of the 1000-krone note.

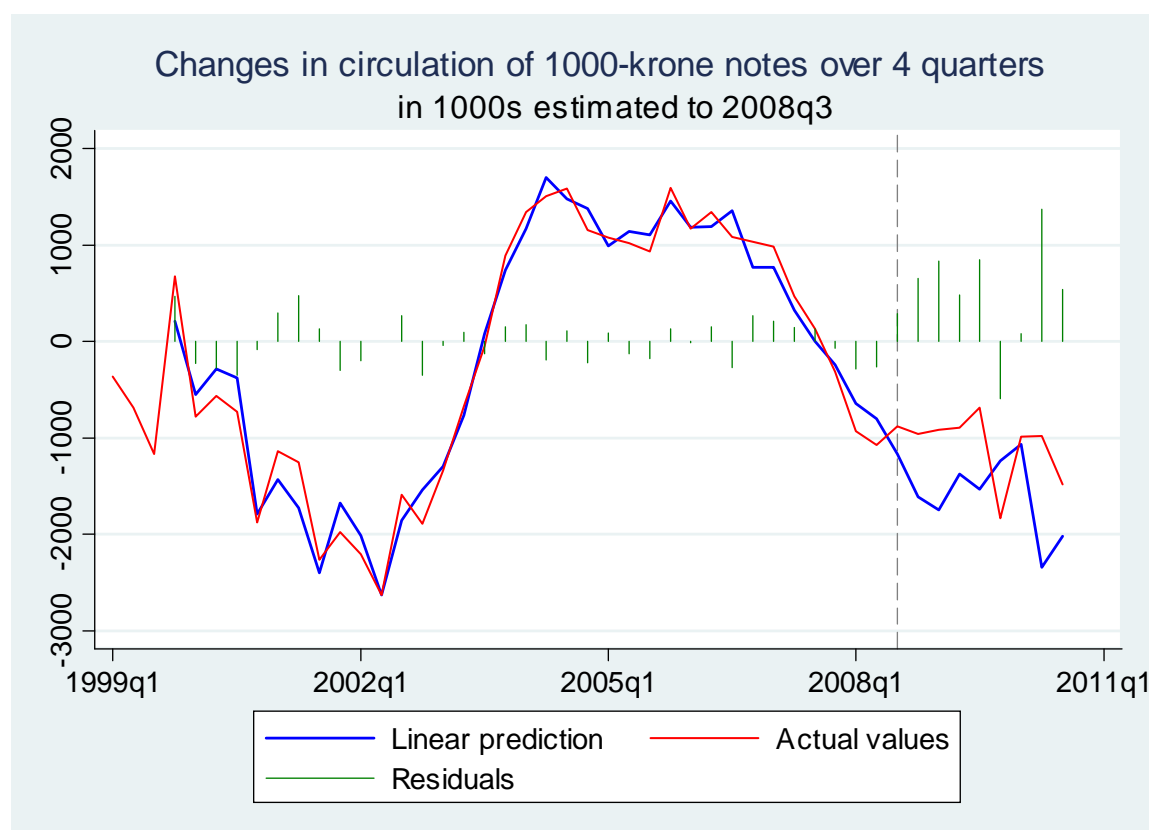

Actual values in red and the predicted values in blue. The residuals or forecast errors are marked as green vertical spikes. Observations to the left of and including at the grey dotted vertical line represent in-sample forecasting, whereas the out of sample forecasting is to the right of the vertical line.

The model predicts well in-sample. However, out-of-sample, i.e., after 2008q3 it tends to underpredict the four quarter change in the circulation of 1000-krone notes. The actual change in the circulation of this note was $-2,164,716$. The smoothed forecast (see section 6.1.1) gives an eight quarter growth of $-3,234,433$. Just adding the the two four quarter forecast to 2009q3 and 2010q3 gives a forecast of $-3,551,821$. I.e., in this case

the smoothed forecast is somewhat closer to the actual value than the one simply adding the two ensuing four quarter forecasts.

6.2. Forecasting models for the coins

Models for the coins are estimated in two steps. In the first step we estimate the long run equilibrium model checking that it is a cointegrating relation and consistent with economic theory. As the 2nd step we insert the residuals of this long run equilibrium model as the error correction term in the short run dynamic model with a lag of four quarters. In estimating this short run model we use the general to specific approach as in estimating the models for banknotes.

6.2.1. 1-krone coin

For the 1-krone coin we first estimate the long run equilibrium model for the sample 1998q1 till 2008q3

$$M1_t = \underset{(18.96)}{280117} + \underset{(10.44)}{1.794}PC_t + \underset{(8.81)}{2.932}etrm_t + \underset{(3.45)}{47273.7}rk_t \quad (6.11)$$

R^2 of this model is 0.9887. Denote the residual of (6.11) as $ECM1_t$ (the error correction term of $M1$). A Dickey-Fuller test of $ECM1_t$ has a test statistic of -3.740 , with a 1% critical value of -3.634 . I.e., the test clearly indicates that (6.11) is a cointegrating relation.

The long run equilibrium demand for 1-krone coins depends positively on POS consumption. As one might expect it also reacted positively to the introduction of interest rate compensation in spite of its low denomination. At first hand somewhat surprisingly, more EFTPOS terminals cause the demand for 1-krone notes to increase. One explanation of this finding can be the following: During the sample period the number of EFTPOS card transactions has increased by a factor of 4, whereas the POS consumption has increased by a little less than 60 per cent.¹² I.e., there has been a huge shift to electronic payments. As consumers switch from using cash to using cards at points of sale, they will to a lesser extent bother to carry a lot of very small denominations like the 1-krone coin in their pockets or purses. This implies that the small denominations consumers receive

¹²See <http://www.norges-bank.no/en/about/published/publications/annual-report-on-payment-systems/> as source for the number of EFTPOS transactions

as change when they actually pay with cash, are not to the same extent recirculated into the banking system. The 1-krone coins not recirculated probably end up in drawers and jars etc. in homes or are simply lost. In the statistics, however, these coins are still registered as in circulation. But because of these disappearing coins, the central bank has to issue more 1-krone coins to the banks in order to keep up with merchants' need for small change. The net result is a higher growth in the number of 1-krone coins statistically in circulation.¹³ This result may seem to contradict findings by Amromin and Chakravorti (2009). However, taking into account that Amromin and Chakravorti consider an aggregate of denominations, several of which have a value far higher than the 1-krone note, the results may be compatible.

The preferred dynamic short run model is

$$\Delta_4 M1_t = \underset{(9.41)}{0.871} \cdot \Delta_4 M1_{t-1} - \underset{(-1.78)}{0.104} ECM1_{t-4} \quad (6.12)$$

$$+ \underset{(1.09)}{0.682} \cdot \Delta_4 PC_t + \underset{(2.88)}{5904.2} \cdot \Delta rk_{t-1}$$

| | | |
|----------------|-------------|------|
| R^2 | 0.9860 | |
| AR 1–2 test | $F(2, 32)$ | 0.46 |
| ARCH 1–1-test | $F(1, 32)$ | 0.05 |
| Normality test | $\chi^2(2)$ | 0.85 |
| Hetero test | $F(7, 26)$ | 0.31 |
| Hetero-X test | $F(13, 20)$ | 0.45 |
| RESET test | $F(1, 33)$ | 0.12 |
| Number of obs. | 38 | |

For the misspecification tests, p -values are reported.

The model passes the misspecification tests except for the ARCH 1–1 test.

Below, we plot the actual values and the forecasted values of the four quarterly changes in the circulation of the 1-krone coin.

¹³We also estimated a similar forecasting model for the 50-øre coin and found the same effect from increased number of EFTPOS terminals. That model is not reported here, since the 50-øre coin is no longer legal tender after 1 May 2012.

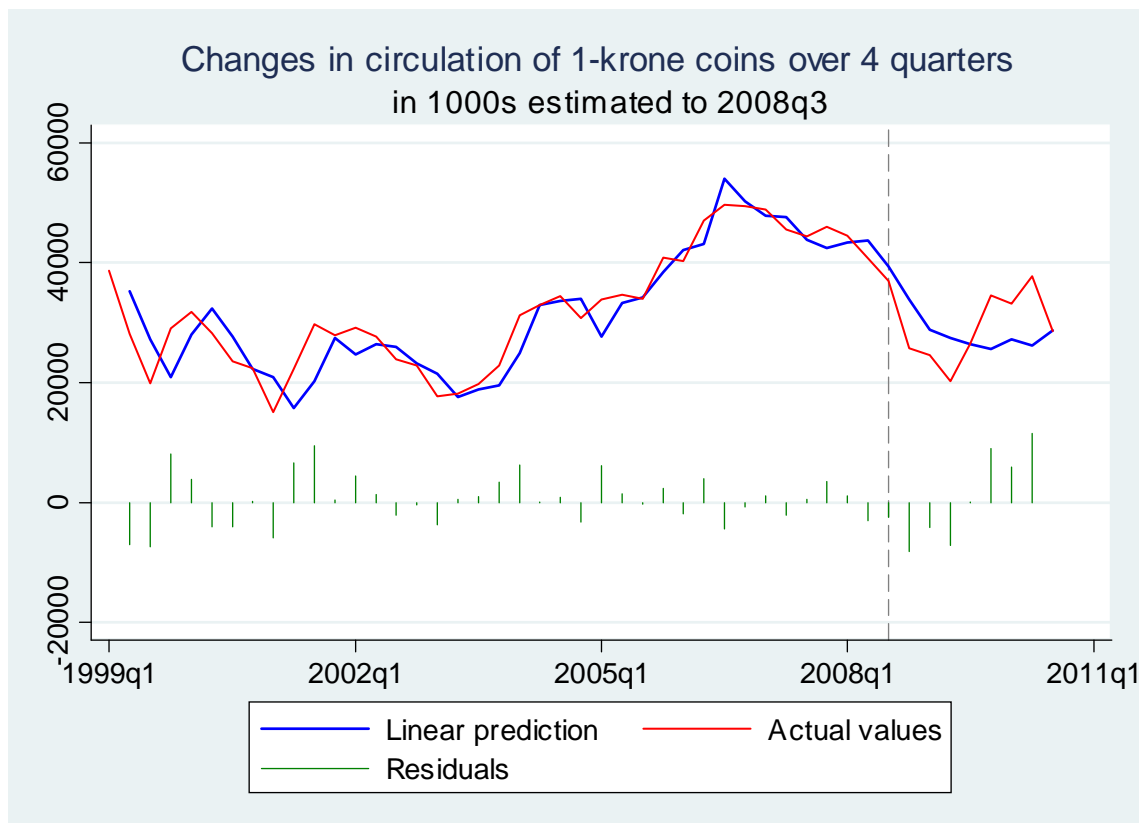

Actual values in red and the predicted values in blue. The residuals or forecast errors are marked as green vertical spikes. Observations to the left of and including at the grey dotted vertical line represent in-sample forecasting, whereas the out of sample forecasting is to the right of the vertical line.

The model predicts well in-sample. In the first part of the out-of-sample period the model overpredicts a little, whereas it underpredicts in the last part. The actual change in the number of 1-krone coins in circulation during the 8 quarters following 2008q3 was 55,155,570. The forecast using the smoothing method, explained in Section 6.1.1, is 56,085,280. By just adding the two 3rd quarter forecasts following 2008q3 we get 55,177,540. Both forecasts are close the actual value, but by just adding the two 3rd quarter forecasts we get closest to the actual number.

6.2.2. 5-krone coin

For the 5-krone coin we first estimate the long run equilibrium model for the sample 1998q1 to 2008q3

$$M5_t = \underset{(6.00)}{26967.5} + \underset{(16.95)}{0.821}PC_t + \underset{(3.07)}{3513.4}rk_t + \underset{(9.33)}{9686.4}q1_t + \underset{(5.63)}{3838.5}q2_t + \underset{(2.17)}{1349.7}q3_t \quad (6.13)$$

R^2 of this model is 0.9832. The Dickey-Fuller stationarity test of the residual of (6.13) $ECM5_t$, gives a test statistic of -4.729 with a 1% critical value of -3.634 . Hence, (6.13) is cointegrating.

As with other denominations, the equilibrium demand for 5-krone coins depends positively on POS consumption and it also reacts positively to the introduction of interest rate compensation to banks and their cash depositories for storing cash. Unlike the 1-krone coin there is no effect on the demand for 5-krone coins from the number of EFTPOS terminals.

The preferred short run dynamic model for the 5-krone note is

$$\begin{aligned} \Delta_4 M5_t = & \underset{(6.18)}{0.569} \cdot \Delta_4 M5_{t-1} - \underset{(-3.67)}{0.546} \cdot ECM5_{t-4} \\ & + \underset{(3.83)}{0.341} \cdot \Delta_4 PC_t + \underset{(2.98)}{1508.4} \cdot \Delta rk_t \end{aligned} \quad (6.14)$$

| | | |
|----------------|-------------|------|
| R^2 | 0.9609 | |
| AR 1–2 test | $F(2, 32)$ | 0.03 |
| ARCH 1–1-test | $F(1, 32)$ | 0.51 |
| Normality test | $\chi^2(2)$ | 0.46 |
| Hetero test | $F(7, 26)$ | 0.19 |
| Hetero-X test | $F(13, 20)$ | 0.26 |
| RESET test | $F(1, 33)$ | 0.79 |
| Number of obs. | 38 | |

For the misspecification tests, p -values are reported.

The model passes the misspecification tests except for the AR 1–2 test.

Below, we plot the actual values and the forecasted values of the four quarterly changes in the circulation of the 5-krone coin.

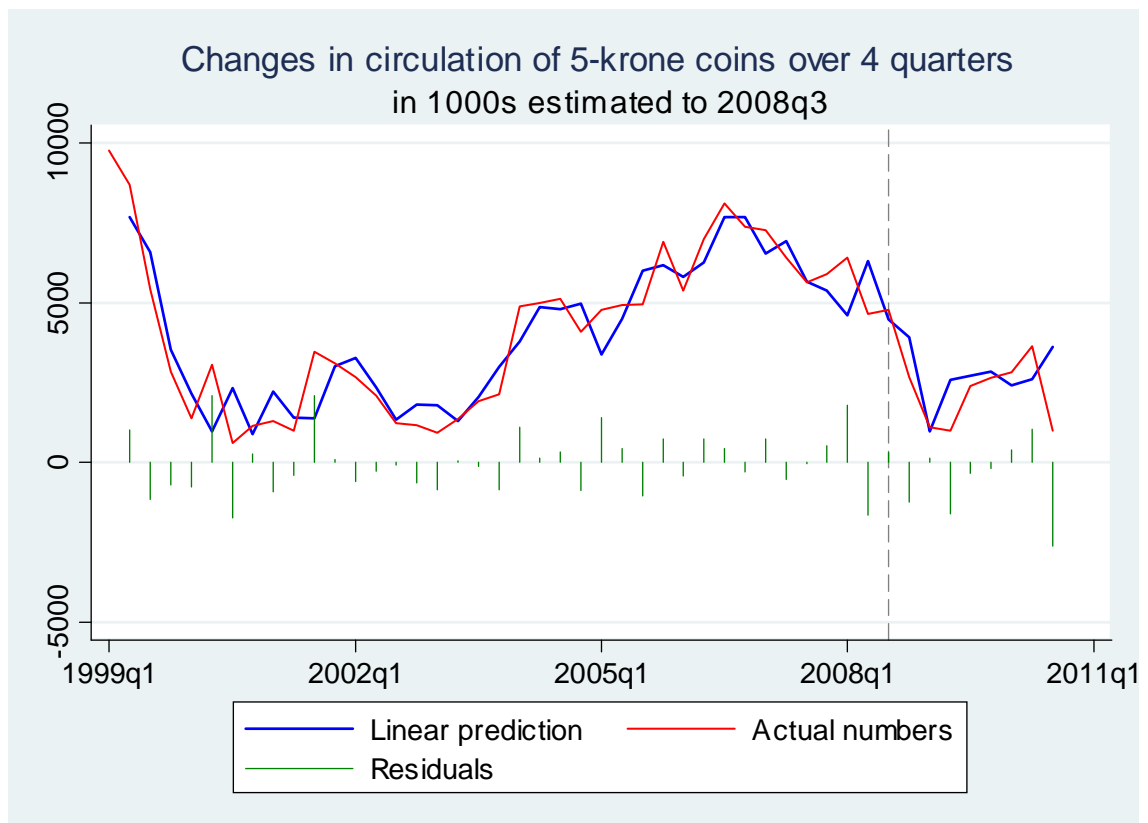

Actual values in red and the predicted values in blue. The residuals or forecast errors are marked as green vertical spikes. Observations to the left of and including at the grey dotted vertical line represent in-sample forecasting, whereas the out of sample forecasting is to the right of the vertical line.

The model predicts relatively well in-sample. Out-of-sample it seems to overpredict somewhat more than it underpredicts. The actual 8 quarter change in the circulation of 5-krone coins after 2008q3 was 3,384,044 coins. The forecast for the same period using the smoothing method described in Section 6.1.1 is 5,413,705. By instead just adding the two four quarter forecasts for 2009q3 and 2010q3 we get 6,333,825. Hence in this case the smoothing method gives a better forecast than just adding the two four quarter forecasts.

6.2.3. 10-krone coin

For the 10-krone coin we did not succeed in finding a cointegrating long run equilibrium relationship. Hence, we are left to rely on a short run dynamic model only containing

variables as first-differences and dummies. The preferred model is as follow

$$\begin{aligned} \Delta_4 M10_t = & \underset{(5.59)}{0.593} \cdot \Delta_4 M_{t-1} - \underset{(-3.34)}{0.219} \cdot \Delta_4 M_{t-4} & (6.15) \\ & + \underset{(2.98)}{0.249} \cdot \Delta_4 PC_{t-1} + \underset{(2.75)}{0.218} \cdot \Delta_4 PC_{t-2} \\ & + \underset{(7.12)}{2028.5} \cdot \Delta_4 rk_{t-3} - \underset{(-2.52)}{1353.7} \cdot DM10_t - \underset{(-2.99)}{1996.6} \cdot DM10_{t-3} \end{aligned}$$

| | | |
|----------------|-------------|------|
| R^2 | 0.9767 | |
| AR 1-2 test | $F(2, 26)$ | 0.58 |
| ARCH 1-1-test | $F(1, 26)$ | 0.78 |
| Normality test | $\chi^2(2)$ | 0.38 |
| Hetero test | $F(11, 16)$ | 0.99 |
| RESET test | $F(1, 27)$ | 0.63 |
| Number of obs. | 35 | |

For the misspecification tests, p -values are reported.

The model passes all the misspecification test. We also check that its error term is stationary. The Dickey-Fuller test statistic is -7.558 versus a critical 1% value of 3.689 . Hence, the error term can be considered stationary.

The four quarter change in POS consumption contributes to explain the four quarter growth in the circulation of 10-krone coins. There was also a boost to the demand for 10-krone coins from the introduction of interest compensation to banks and their cash deposits for holding notes and coins. In addition, the period between early 2002 and early 2004 when slot machines machines became more strictly regulated had a clear negative impact on the demand for 10-krone coins.

Below, we plot the actual values and the forecasted values of the four quarterly changes in the circulation of the 10-krone coin.

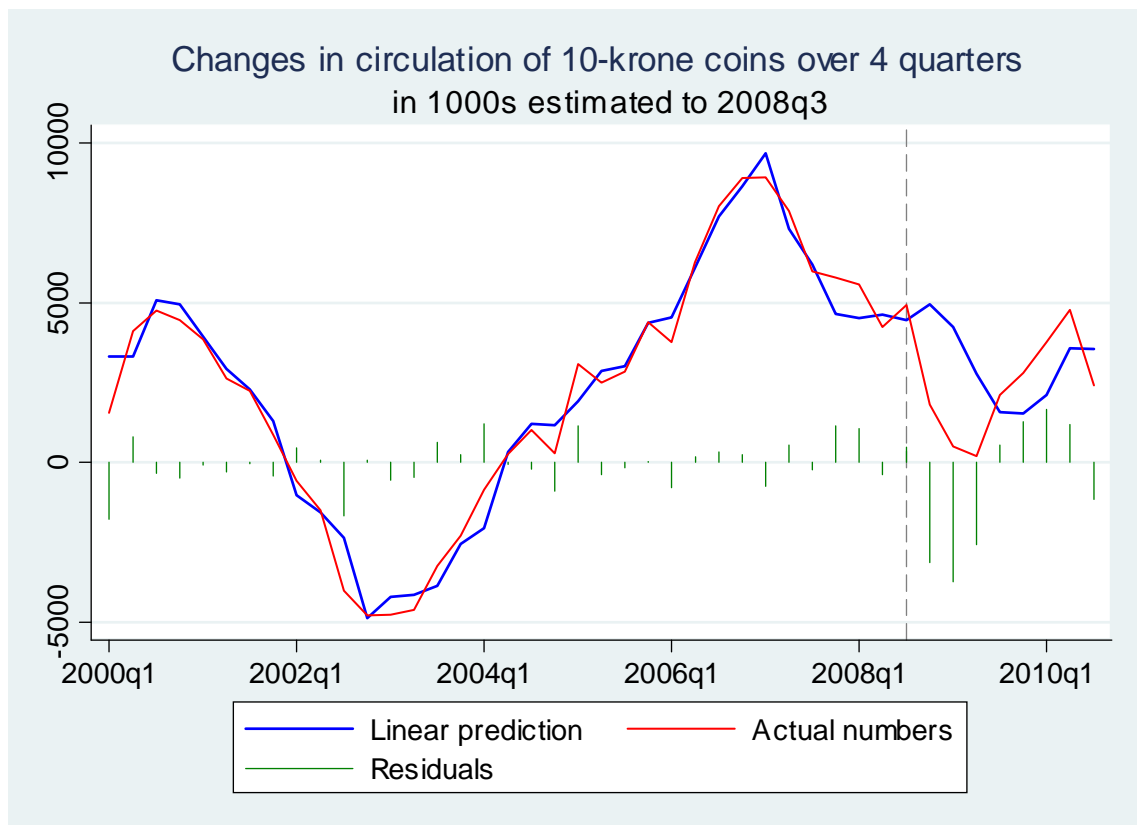

Actual values in red and the predicted values in blue. The residuals or forecast errors are marked as green vertical spikes. Observations to the left of and including at the grey dotted vertical line represent in-sample forecasting, whereas the out of sample forecasting is to the right of the vertical line.

The model predicts well in-sample. Out-of-sample, i.e., after 2008q3 it first has a tendency of overpredicting, then underpredicting somewhat the growth in the demand for 10-krone coins. The actual 8 quarter growth in the circulation of 10-krone coins after 2008q3 was 4,523,668. Using the smoothing method described in Section 6.1.1 we get a forecast of the 8 quarter growth from 2008q3 at 6,080,144. If instead we simply add the two four quarter forecasts ending in 2009q3 and 2010q3 we get a forecast of 5,135,694. I.e., in this case the simple adding of two four quarter forecasts gives a forecast closer to the actual number than does the smoothing method.

7. Concluding remarks

In this paper, based on quarterly data, we have presented a set of error correction models in order to forecast the change in demand for notes and coins issued by Norges Bank. We have estimated one model for each denomination. Such forecasts can play a role in planning how many new banknotes and coins Norges Bank should order from its producers.

The variables upon which we condition the forecasts: households' point of sales consumption, the number of EFTPOS terminals, money market interest rate, as well as the ability of banks to receive interest payments for cash they keep in their vaults, have good foundation in economic theory on demand for cash. Furthermore, they are also found to influence demand for banknotes and coins in empirical papers using data from other countries. This holds to a large extent true for studies estimating demand for aggregates of all denominations and studies estimating demand for larger versus smaller denominations. Interestingly, we made one finding which we are not aware of in any other studies: as consumers to a larger extent use EFTPOS cards for their point of sales consumption holdings of the lowest value denomination coins increases, something we attribute to consumers leaving stocks of low value coins at home since they are less frequently used for paying.

Our models produce four quarters forecast of the change in demand for the various denominations. The typical interval between orders of new supplies for a denomination is 8 quarters. The out-of-sample forecasts for the change in demand over this horizon (8 quarters) perform reasonably well. However, quarter by quarter our four quarters forecasts may be quite inaccurate. In order to arrive at a more reliable number for the change in demand over an 8 quarters horizon we need to smooth the quarter by quarter forecasts by using an average. Instead of smoothing one could just add the two sequential non-overlapping four quarter forecasts.

In this paper, the method of adding the two four quarter forecasts till 2009q3 and 2010q3 gives predictions closer to the actual numbers than does the smoothing method in five of eight cases. Nevertheless, one should still regard the smoothing method as more reliable, in the sense that getting forecasts that are far away from the true numbers is less likely with the smoothing method. As can be seen from the plots, relying on just one or two observations in the post sample period may lead one to pick observations that deviate the most and in the same direction from the actual numbers. The simple adding method scoring 5 – 3 over the smoothing method in the results presented here, is most likely a coincidence.

Alternatively, one could have tried using a vector error correction approach or a structural VAR approach in order to capture interdependencies between various denominations. However, we leave that for future research.

References

- Aastveit, K. A. (2005, February). The demand for cash in Norway. Master's thesis, University of Oslo, Department of Economics.
- Amromin, G. and S. Chakravorti (2009). Whither loose change? The diminishing demand for small-denomination currency. *Journal of Money, Credit and Banking* 41(2–3), 315–334.
- Bergman, M., G. Guibourg, and B. Segendorf (2007). The costs of paying – private and social costs of cash and card payments. Sveriges Riksbank Working Paper Series 212, Sveriges Riksbank.
- Bolt, W., D. B. Humphrey, and R. Uittenbogaard (2008). The effect of transaction pricing on the adoption of electronic payments: A cross-country comparison. *International Journal of Central Banking* 4, 89–123.
- Bos, J. W. D. (1994, June). A prediction model for banknote circulation. *De Nederlandse Bank Quarterly Bulletin*, 39–50.
- Drehman, M., C. Goodhart, and M. Krueger (2002, April). The challenges facing currency usage: will the traditional transaction medium be able to resist competition from the new technologies? *Economic Policy*, 195–227.
- Fischer, B. (2012). Forecasting demand for banknotes and how to address the impact of the crisis. In *4th ECB Central Bank Seminar on Banknotes*, Frankfurt am Main.
- Fischer, B., P. Köhler, and F. Seitz (2004). The demand for euro area currencies: Past, present and future. Working Paper 330, European Central Bank.
- Humphrey, D., M. Kim, and B. Vale (2001). Realizing the gains from electronic payments: Costs, pricing, and payment choice. *Journal of Money, Credit, and Banking* 33, 217–234.
- Humphrey, D., L. Pulley, and J. Vesala (1996). Cash, paper and electronic payments: a cross-country analysis. *Journal of Money, Credit, and Banking* 28, 914–939.

ten Raa, T. and V. Shestalova (2002). Empirical evidence on payment media costs and switch points. *Journal of Banking and Finance* 28, 203–213.